

DXBE-P77-V15A REV 05. Date: 21/11/2017

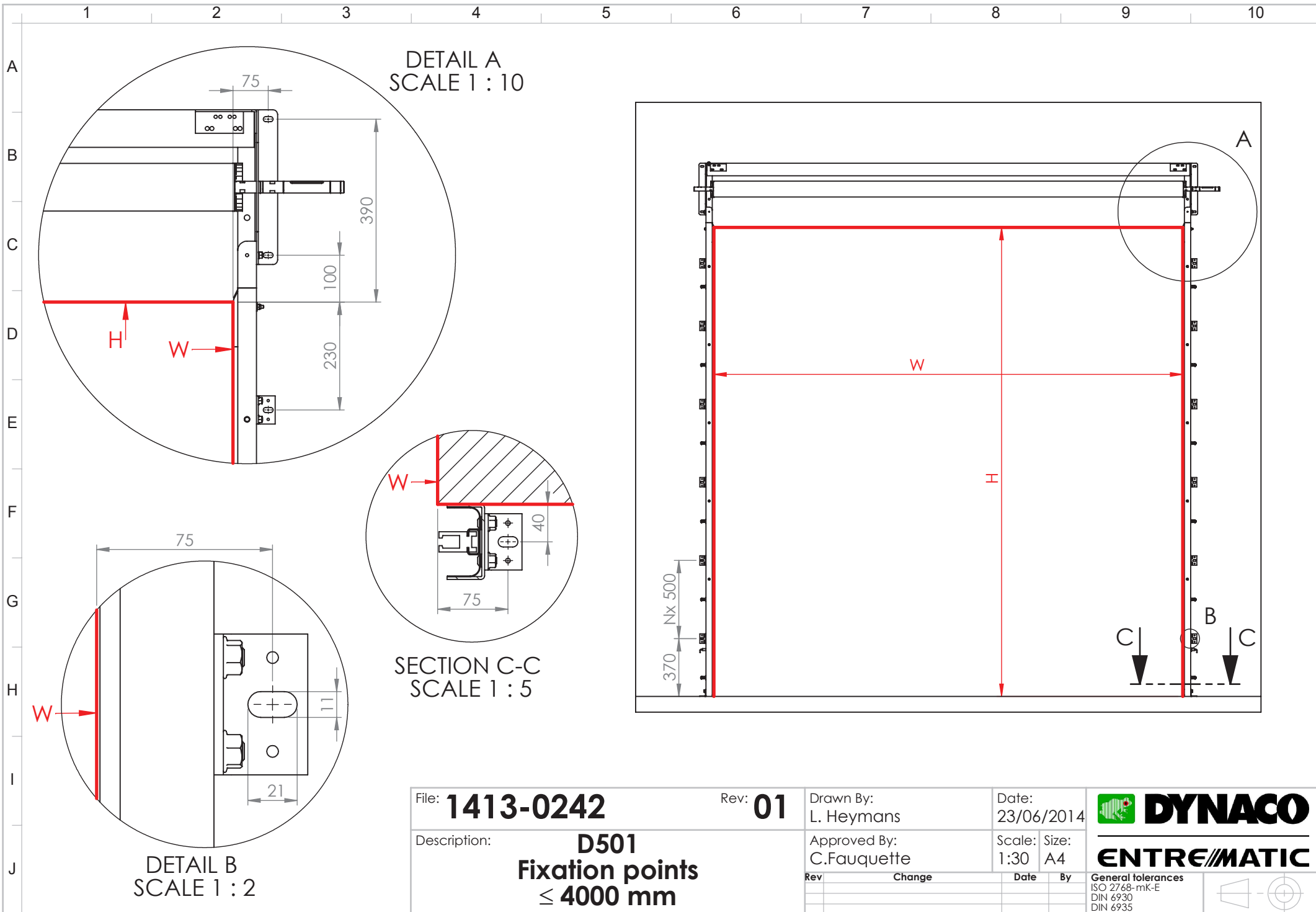

DETAIL A  
SCALE 1 : 10

SECTION C-C  
SCALE 1 : 5

DETAIL B  
SCALE 1 : 2

File: **1413-0242** Rev: **01**  
 Description: **D501**  
**Fixation points**  
**≤ 4000 mm**

Drawn By:  
L. Heymans  
 Approved By:  
C.Fauquette

Date:  
23/06/2014  
 Scale: Size:  
1:30 A4



Rev	Change	Date	By

General tolerances  
 ISO 2768-mK-E  
 DIN 6930  
 DIN 6935

© All rights reserved by Dynaco

This Information is Confidential ©All rights reserved by Entrematic Belgium

DXBE-P77-V15A REV 05. Date: 21/11/2017

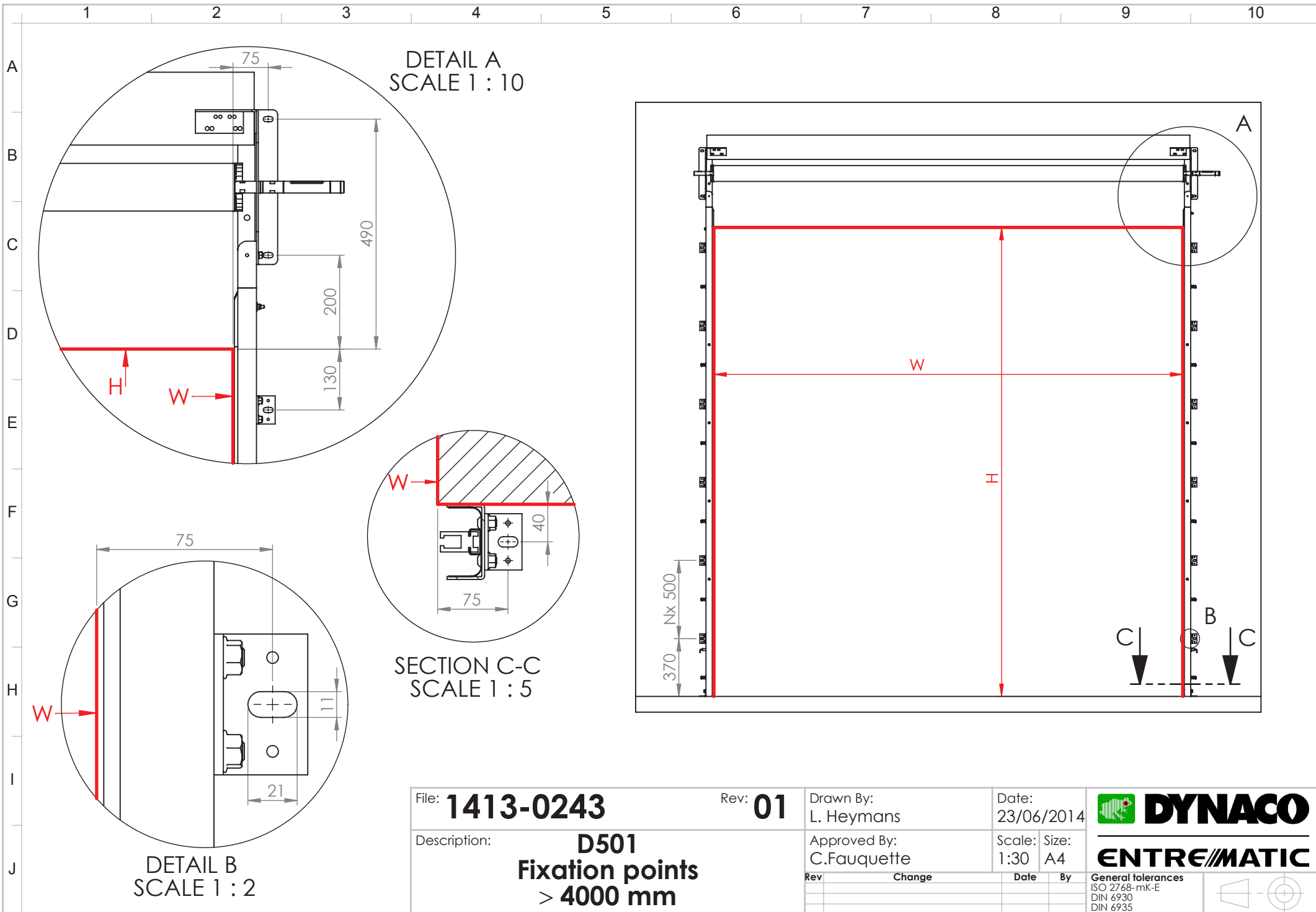

File: **1413-0243** Rev: **01**

Drawn By: L. Heymans

Date: 23/06/2014

Description: **D501**  
**Fixation points**  
**> 4000 mm**

Approved By: C.Fauquette

Scale: 1:30 Size: A4

Rev	Change	Date	By





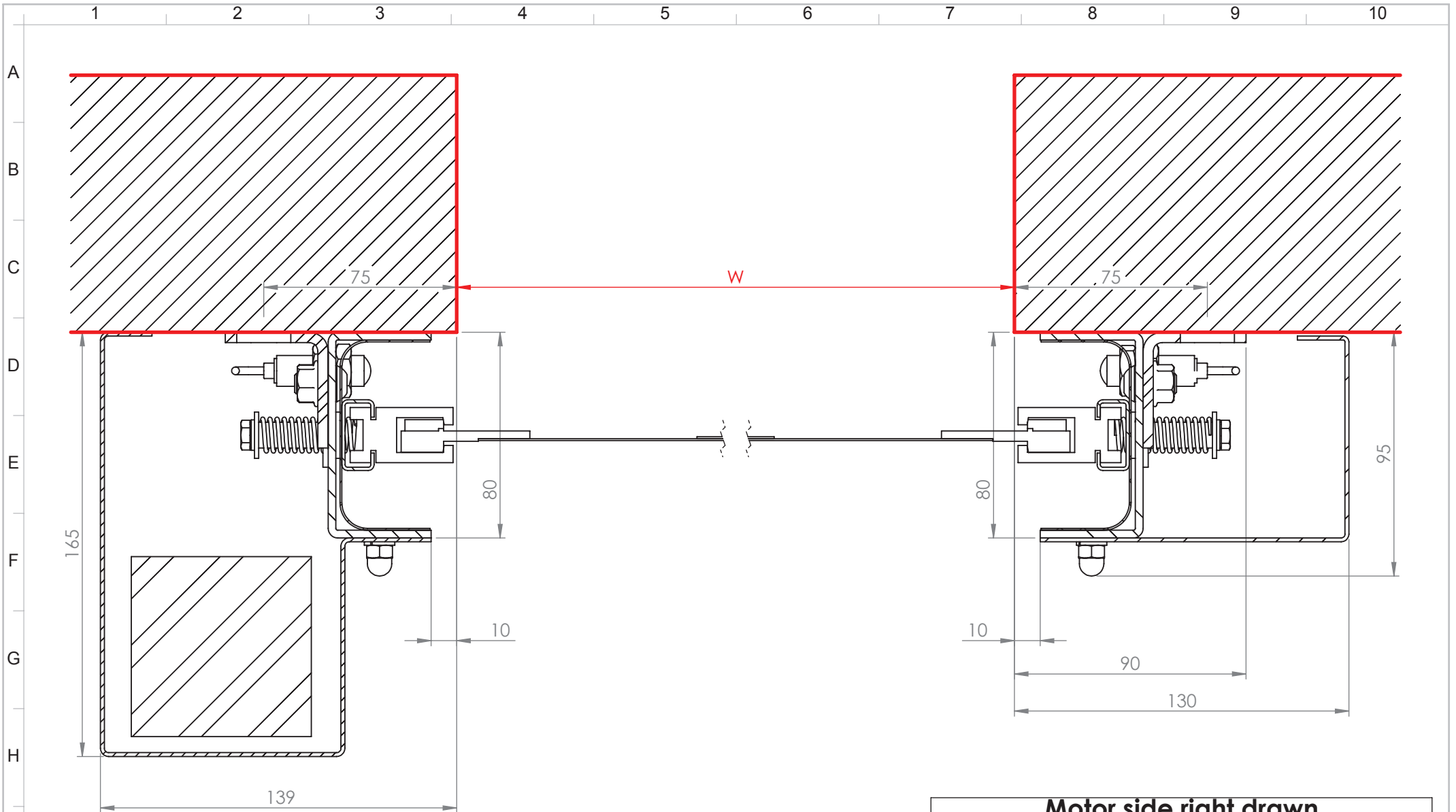

General tolerances  
ISO 2768-mK-E  
DIN 6930  
DIN 6935





**Motor side right drawn**  
**Motor side left = mirror of motor side right**

File: <b>1413-0245</b>	Rev: <b>01</b>	Drawn By: L. Heymans	Date: 24/06/2014	 <b>DYNACO</b>  <b>ENTRE//MATIC</b>											
Description: <b>D501</b> <b>Side guide section view</b>	Approved By: C. Fauquette	Scale: 1:2	Size: A4												
<table border="1"> <thead> <tr> <th>Rev</th> <th>Change</th> <th>Date</th> <th>By</th> </tr> </thead> <tbody> <tr> <td> </td> <td> </td> <td> </td> <td> </td> </tr> </tbody> </table>		Rev	Change	Date	By					<table border="1"> <tr> <td colspan="2">                 General tolerances                  ISO 2768-mK-E                  DIN 6930                  DIN 6935             </td> <td colspan="2">  </td> </tr> </table>		General tolerances ISO 2768-mK-E DIN 6930 DIN 6935			
Rev	Change	Date	By												
General tolerances ISO 2768-mK-E DIN 6930 DIN 6935															

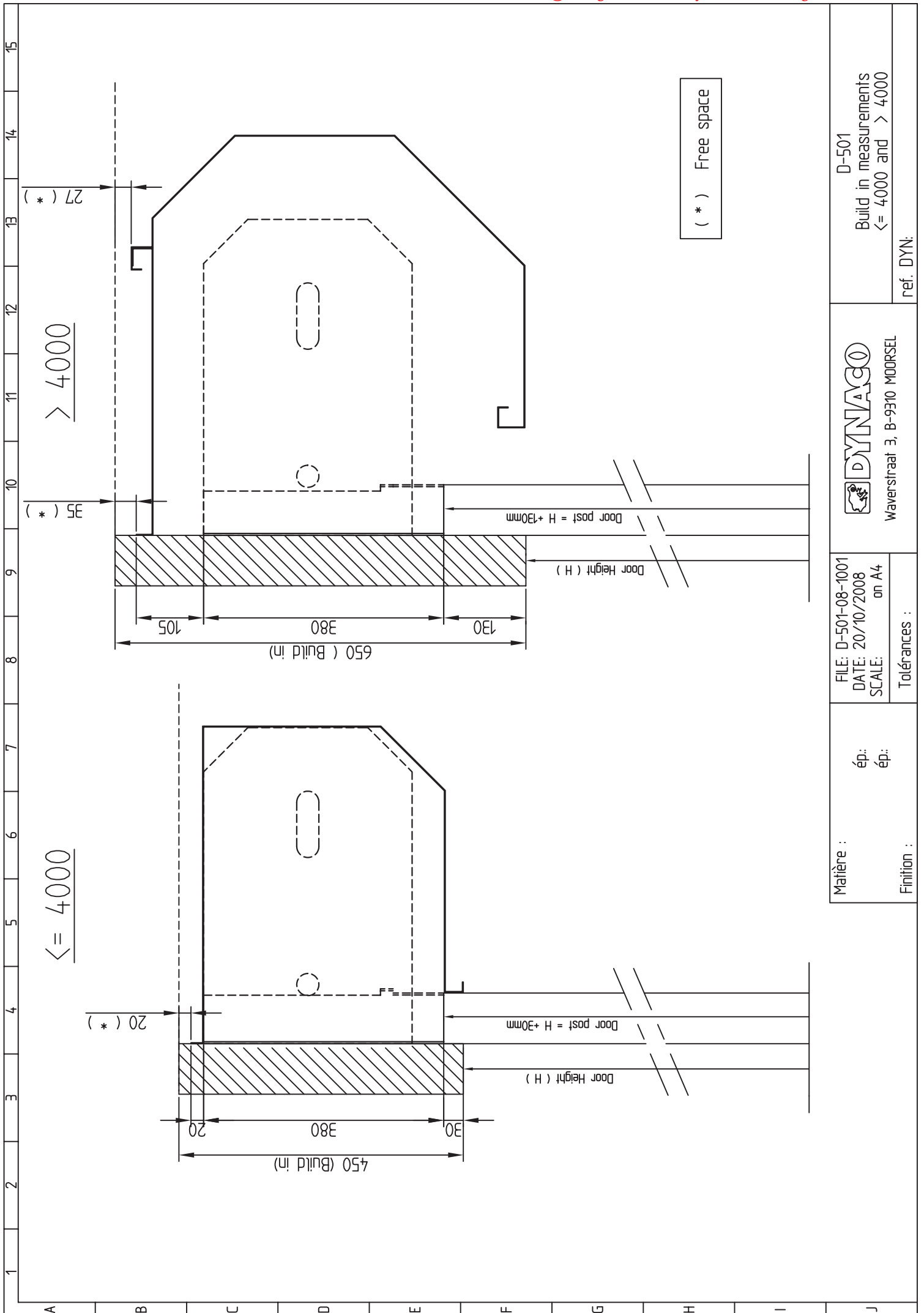

FILE: D-501-08-1001  
 DATE: 20/10/2008  
 SCALE: on A4  
 Tolérances :

Matière :  
 ép.:  
 ép.:  
 Finition :

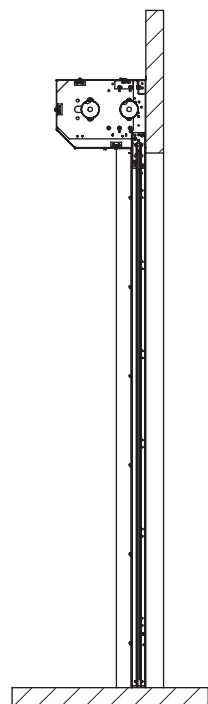

D-501  
 Build in measurements  
 $\leq 4000$  and  $> 4000$   
 ref. DYN:

DY-BE-P77-V15A REV 05. Date: 21/11/2017

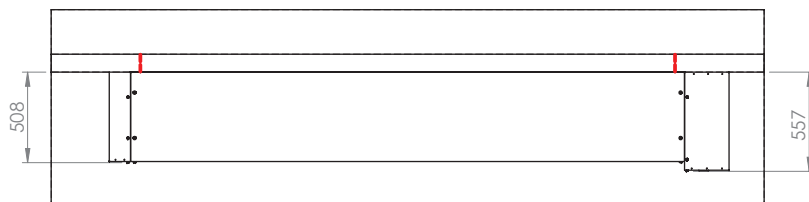
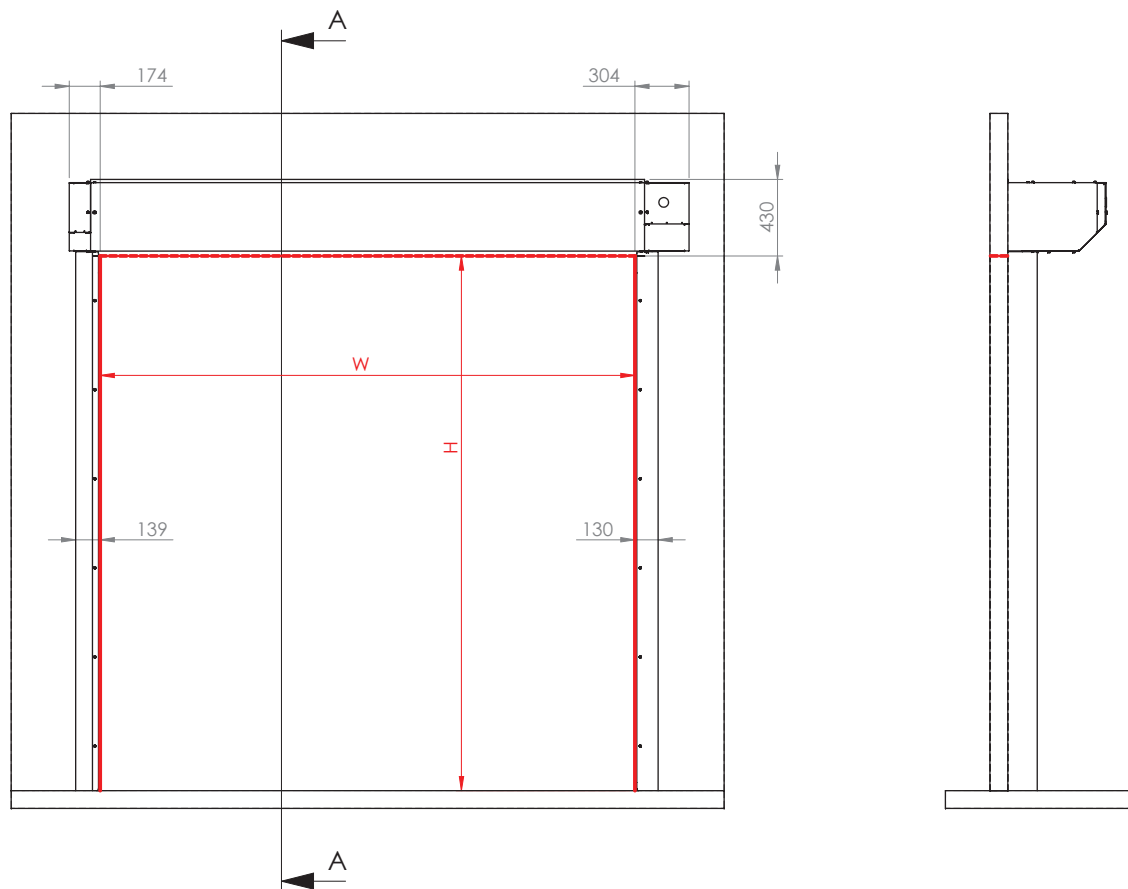
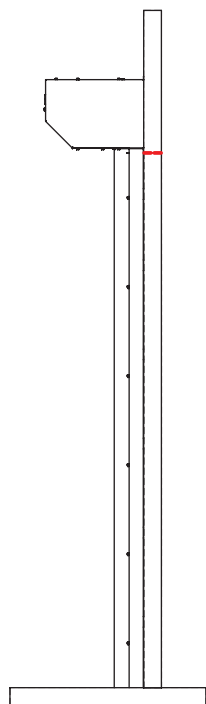

SECTION A-A



File: <b>1413-0177</b>	Rev: <b>02</b>	Drawn By: L. Heymans	Date: 23/06/2014	 <b>ENTRE//MATIC</b>								
Description: <b>D501</b>	Approved By: C. Fauquette	Scale: 1:30	Size: A3									
<b>Built in dimensions</b> <b>With cover ≤ 4000 mm</b>		<table border="1"> <thead> <tr> <th>Rev</th> <th>Change</th> <th>Date</th> <th>By</th> </tr> </thead> <tbody> <tr> <td>02</td> <td>added section view</td> <td>26/06/14</td> <td>LHE</td> </tr> </tbody> </table>	Rev	Change	Date	By	02	added section view	26/06/14	LHE	General tolerances ISO 2768-mK-E DIN 6930 DIN 6935	
Rev	Change	Date	By									
02	added section view	26/06/14	LHE									

© All rights reserved by Dynaco

This Information is Confidential

© All rights reserved by Entrematic Belgium

DY-BE-P77-V15A REV 05. Date: 21/11/2017

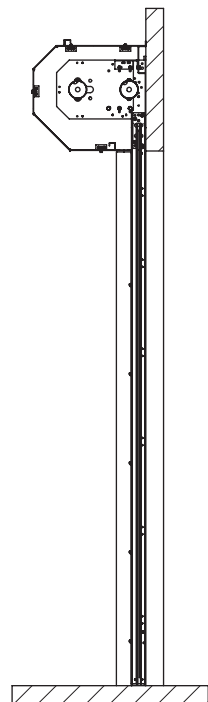

SECTION A-A

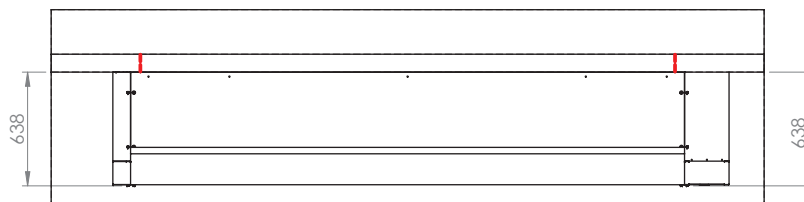
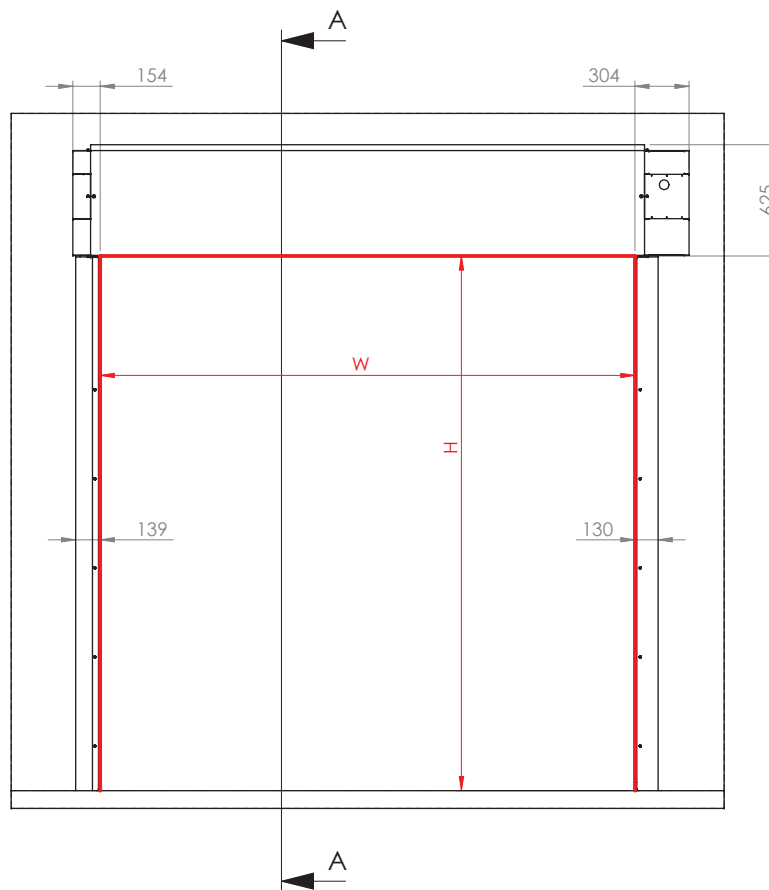
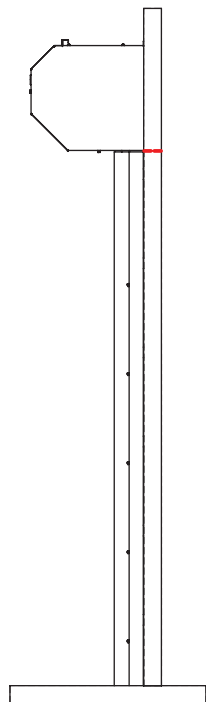

File: **1413-0178** Rev: **02**

Description: **D501**  
**Built in dimensions**  
**With cover > 4000 mm**

Drawn By:  
L. Heymans

Approved By:  
C. Fauquette

Rev: 02  
Change: added section view

Date:  
23/06/2014

Scale: 1:30  
Size: A3

Date: 26/06/14  
By: LHE



General tolerances  
ISO 2768-mK-E  
DIN 6930  
DIN 6935



© All rights reserved by Dynaco

This Information is Confidential

© All rights reserved by Entrematic Belgium

DY-BE-P77-V15A REV 05. Date: 21/11/2017

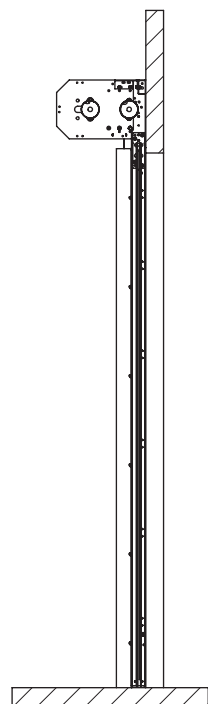

SECTION A-A

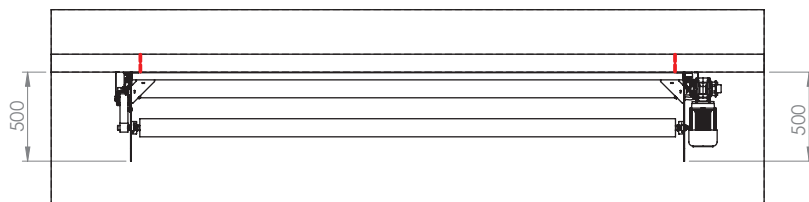
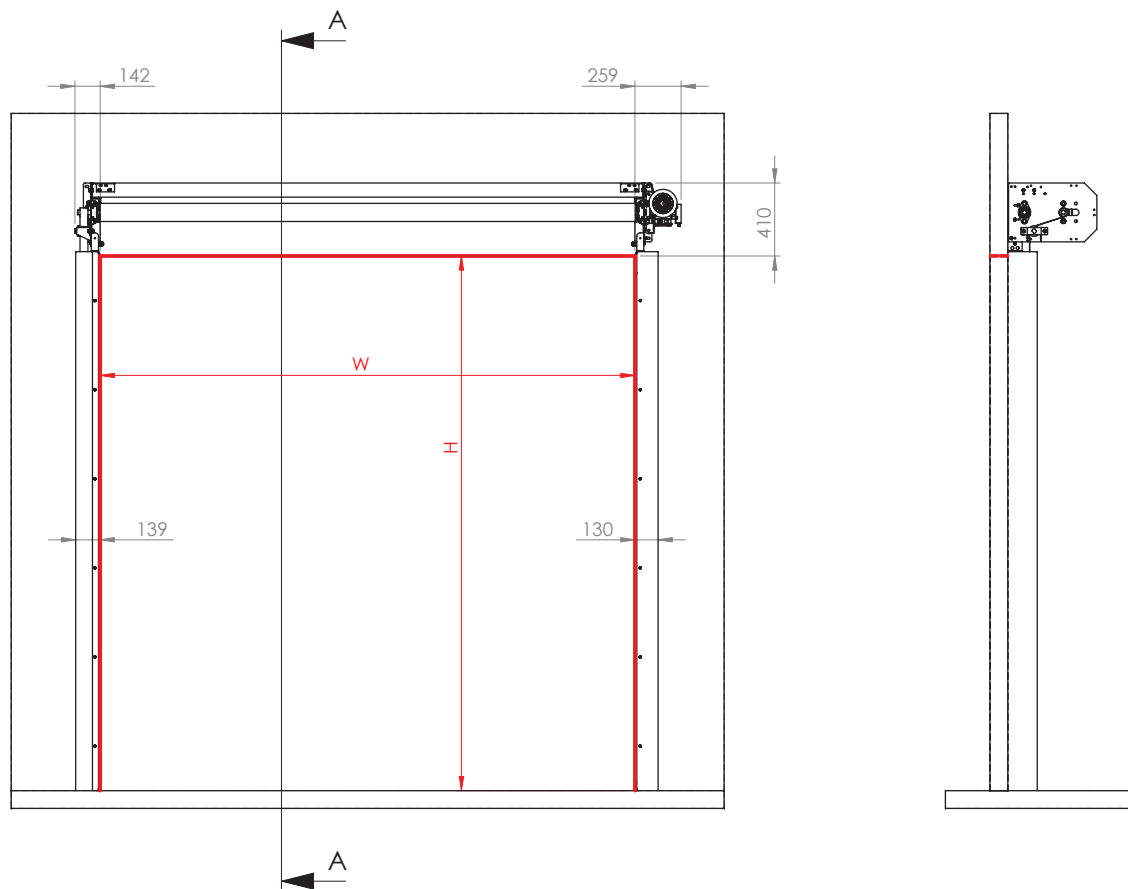
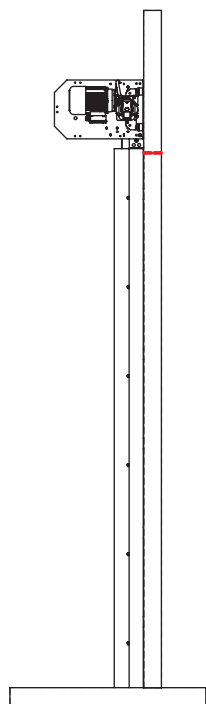

File:	<b>1413-0244</b>	Rev:	<b>01</b>	Drawn By:	L. Heymans	Date:	24/06/2014	 <b>DYNACO</b> <b>ENTRE//MATIC</b>
Description:	<b>D501</b>	Approved By:	C. Fauquette	Scale:	1:30	Size:	A3	
Rev	Change	Date	By	<small>General tolerances          ISO 2768-mK-E          DIN 6930          DIN 6935</small>				

**Built in dimensions without cover ≤ 4000 mm**

This Information is Confidential © All rights reserved by Entrematic Belgium

© All rights reserved by Dynaco

DY-BE-P77-V15A REV 05. Date: 21/11/2017

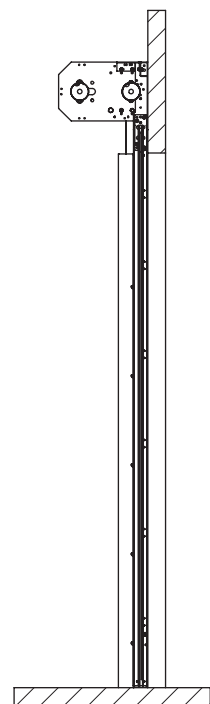

SECTION A-A

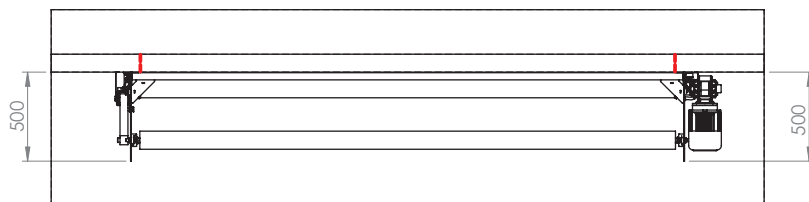
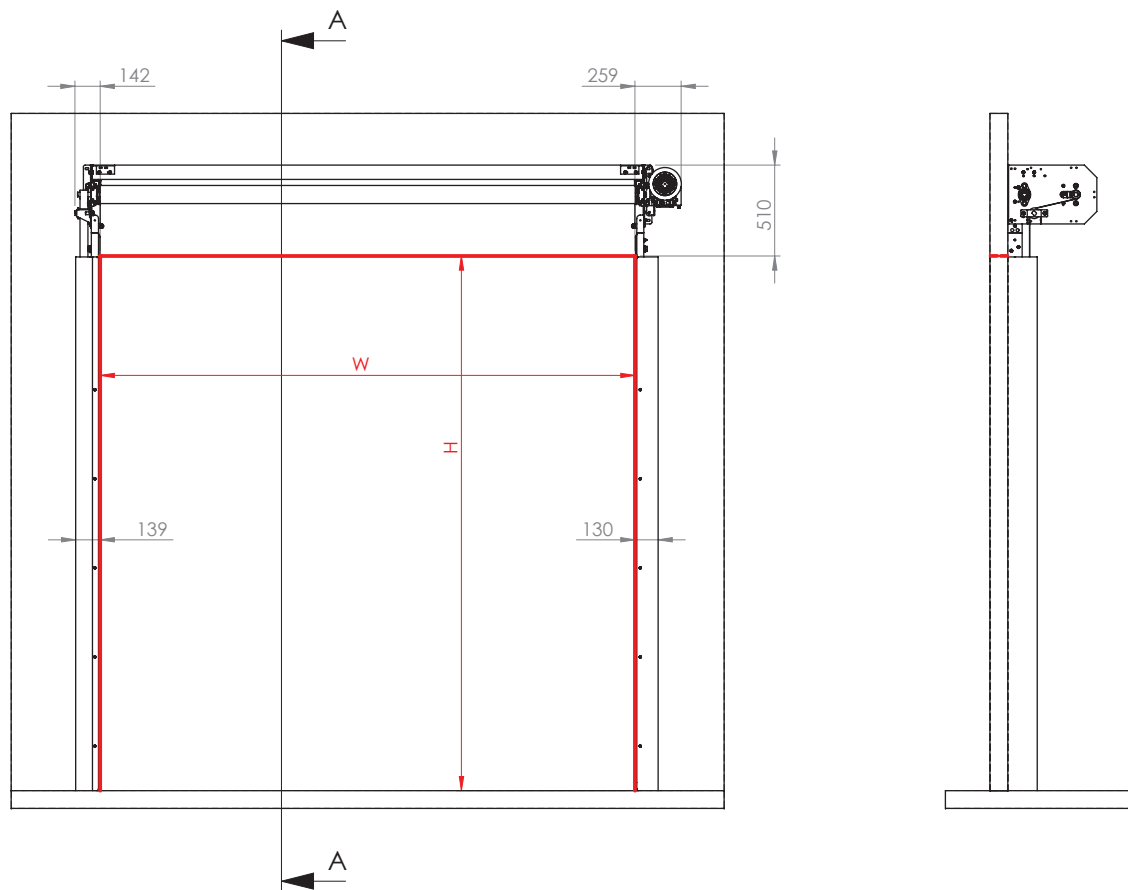
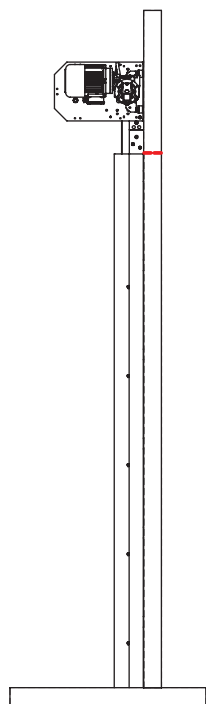

File: <b>1413-0246</b>	Rev: <b>02</b>	Drawn By: L. Heymans	Date: 1/07/2014	 <b>ENTRE//MATIC</b>								
Description: <b>D501</b>		Approved By: C. Fauquette	Scale: Size: 1:30 A3									
<b>Built in dimensions</b> <b>Without cover &gt; 4000 mm</b>		<table border="1"> <thead> <tr> <th>Rev</th> <th>Change</th> <th>Date</th> <th>By</th> </tr> </thead> <tbody> <tr> <td> </td> <td> </td> <td> </td> <td> </td> </tr> </tbody> </table>		Rev	Change	Date	By					General tolerances ISO 2768-mK-E DIN 6930 DIN 6935
Rev	Change	Date	By									

© All rights reserved by Dynaco

This Information is Confidential © All rights reserved by Entrematic Belgium